



LEANTOOL

Radial / Progressive

Standardized modular
tool kit for (G)RM-NC

SURELY SIMPLE

LEANTOOL system for new tools

With the LEANTOOL system, you now implement new tools easier, faster and cheaper. Based on the RM-NC and GRM-NC servo stamping and forming machines, the standardized modular tool kit covers the entire spectrum of stamped and formed parts – from simple wire and strip bending parts to the most complex progressive components.

The LEANTOOL system impresses with its perfect consistency from planning and design all the way to manufacturing and production. You benefit from rapid implementation times and up to 70 percent lower costs compared to conventional tools on mechanical machines and presses. New products can be brought to market before your competitors, even with very small batch sizes.

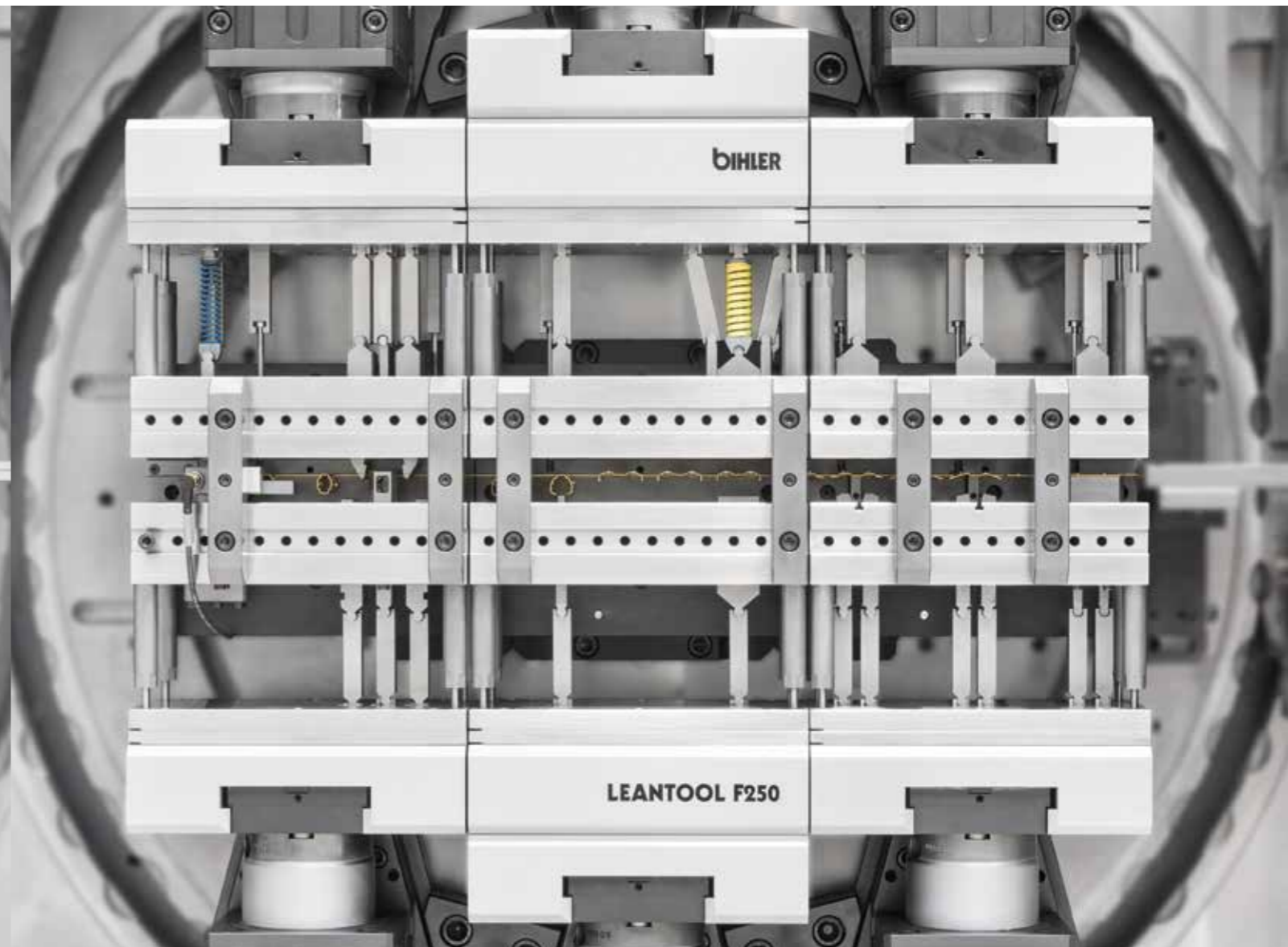
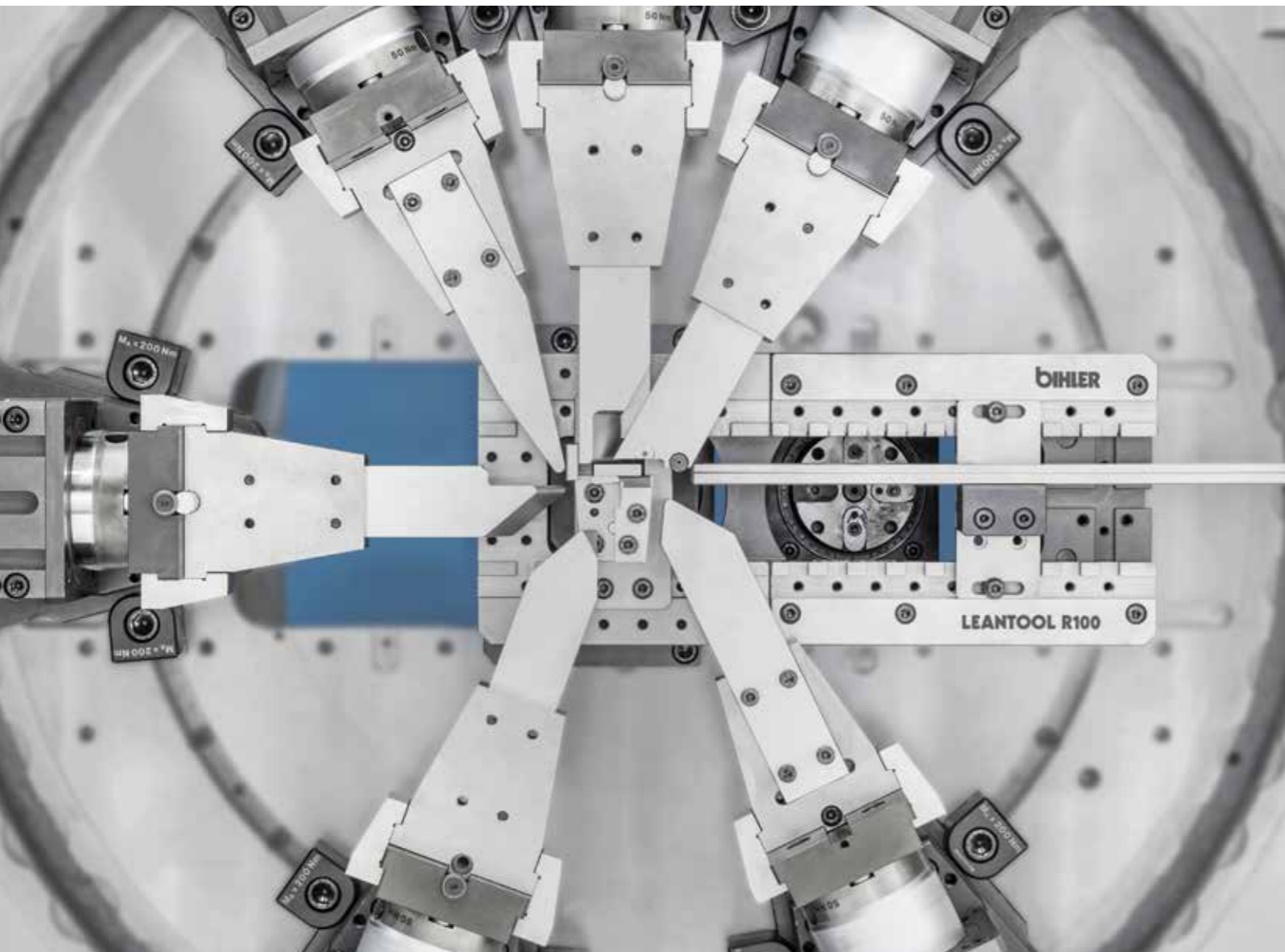

LEANTOOL system

Highlights

Key features of the LEANTOOL system

- Very fast "Time to Market" for new stamped and formed parts, wire bending parts and progressive components
- Very fast feasibility statements and precise quotations ("Bihlerplanning" WebApp; defined process limits)
- Simple and structured design methodology of bNX software (design support with new bNX applications and templates)
- Very short tool production times (high proportion of standard parts and blanks)
- Up to 70% lower manufacturing costs compared to conventional tool technologies
- Extremely fast, 100% reproducible setup operations (automatic positioning of servo units, quick clamping systems, data retrieval from VC 1 control system)
- Lower logistics and maintenance costs



LEANTOOL system

Perfect consistency



1. PLANNING (WebApp)

Simple, fast feasibility statement

- Clearly defined workspace
- Quick and easy planning of process sequences
- Plausible calculation specified by tool setup (modular system)

www.bihlerplanning.de

2. DESIGN (bNX)

Simple, clearly structured design

- Predefined machine environment and standard parts
- All LEANTOOL standard parts in reuse library
- Simple design methodology
- Typical application examples included



6. PRODUCTION

Highly productive and accurate production on RM-NC and GRM-NC

- Fast cycle speeds up to 300 1/min.
- Extremely short setup times (30 to 60 min.)
- Automatically reproducible setup
- Full tool accessibility

3. MANUFACTURING

Fast, efficient manufacturing

- Small number of components
- High degree of standardization (70% standard parts)
- Individual tool parts reduced to a minimum
- Many standard parts readily available from stock



5. SETUP

Simple, fast tool setup

- Standardized machine design
- Setup of servo units with VC 1
- Standardized, uniform quick clamping systems for tool modules
- Faster optimization of forming results through servo technology

4. INSTALLATION

Simple, quick tool installation

- Modular tool design
- Standardized tool units (pilots, punches, spring assemblies)
- No cam discs



LEANTOOL PRINCIPLE

Maximum standardization

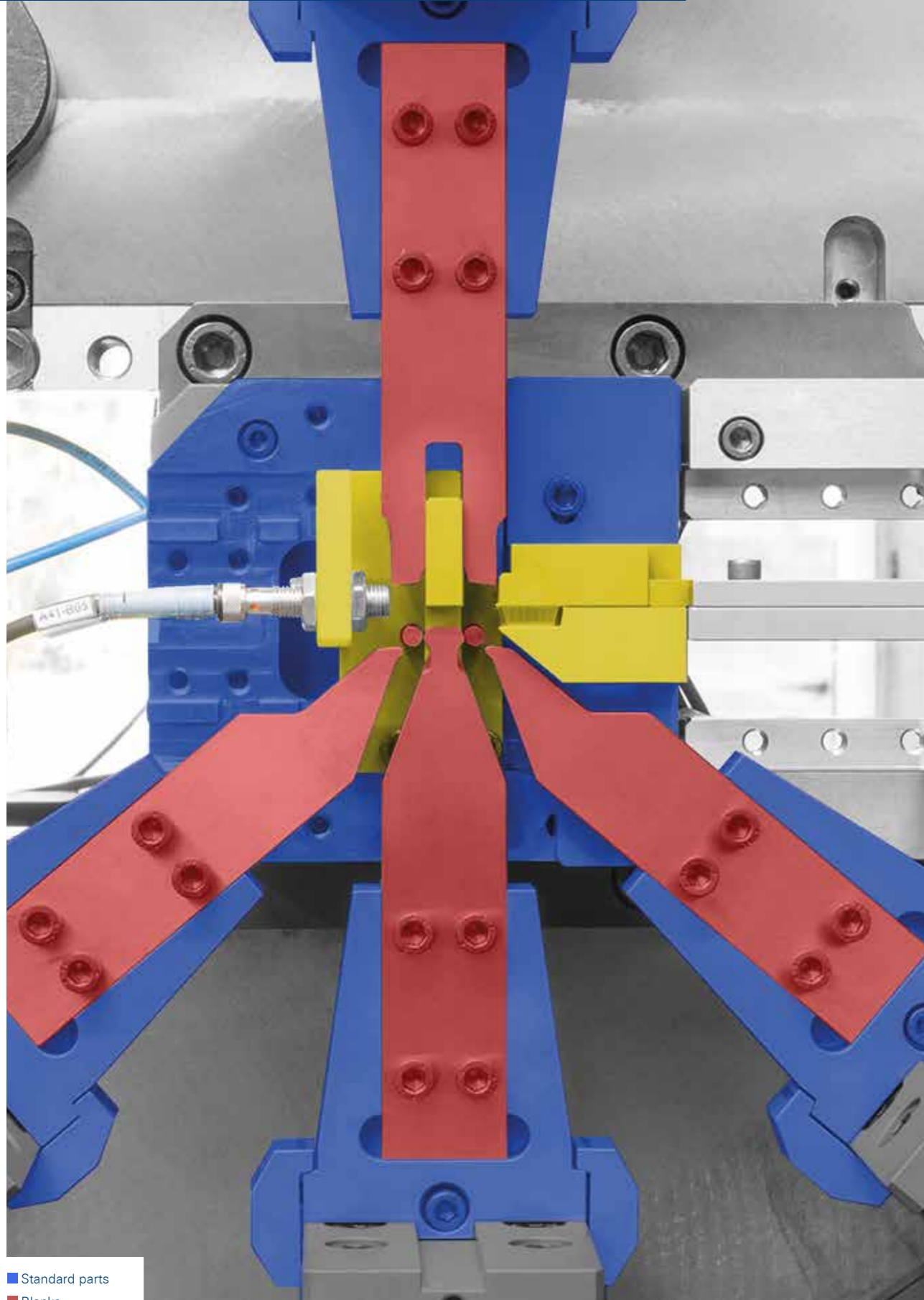

- Standard parts
- Blanks
- Individual tool parts

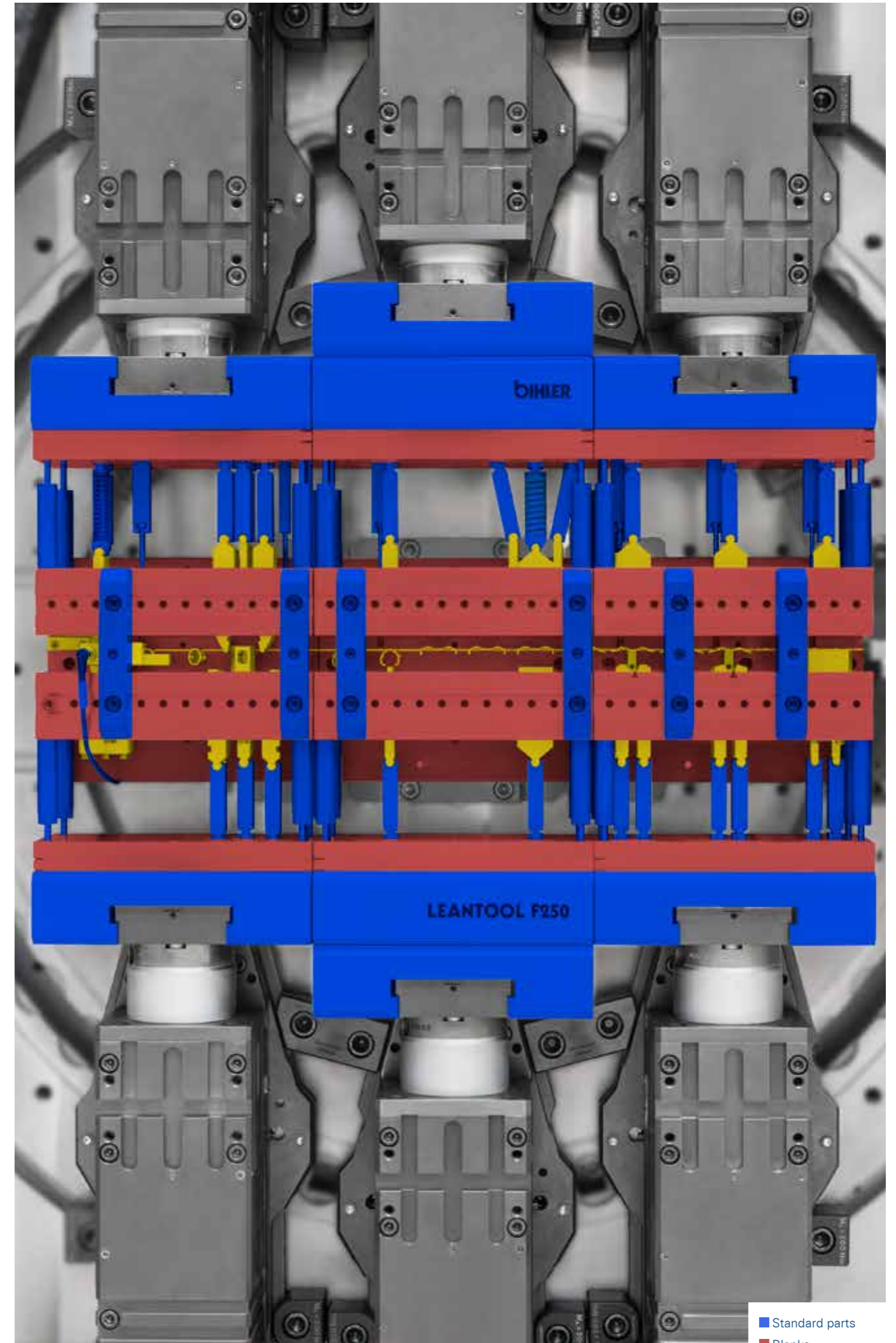

- Standard parts
- Blanks
- Individual tool parts

LEANTOOL

Radial

Application:
Implementing new tools according to the radial principle

Highlights at a glance

- Up to 70% standard tools regardless of task
- Up to 70% lower manufacturing costs compared to conventional radial tools
- Bending in the ideal grain direction
- Strip width in accordance with part width: production with minimum material waste
- Optimum bending angle infinitely adjustable



LEANTOOL Radial is an intelligent optimization of the existing Bihler radial principle. Thanks to the innovative features of the (G)RM-NC servo machines and the servo-controlled bending units, the number of parts in a LEANTOOL radial tool can be reduced to a minimum. The tool parts also consist of 70% standard parts, and do not have to be reworked or only have to be reworked slightly.

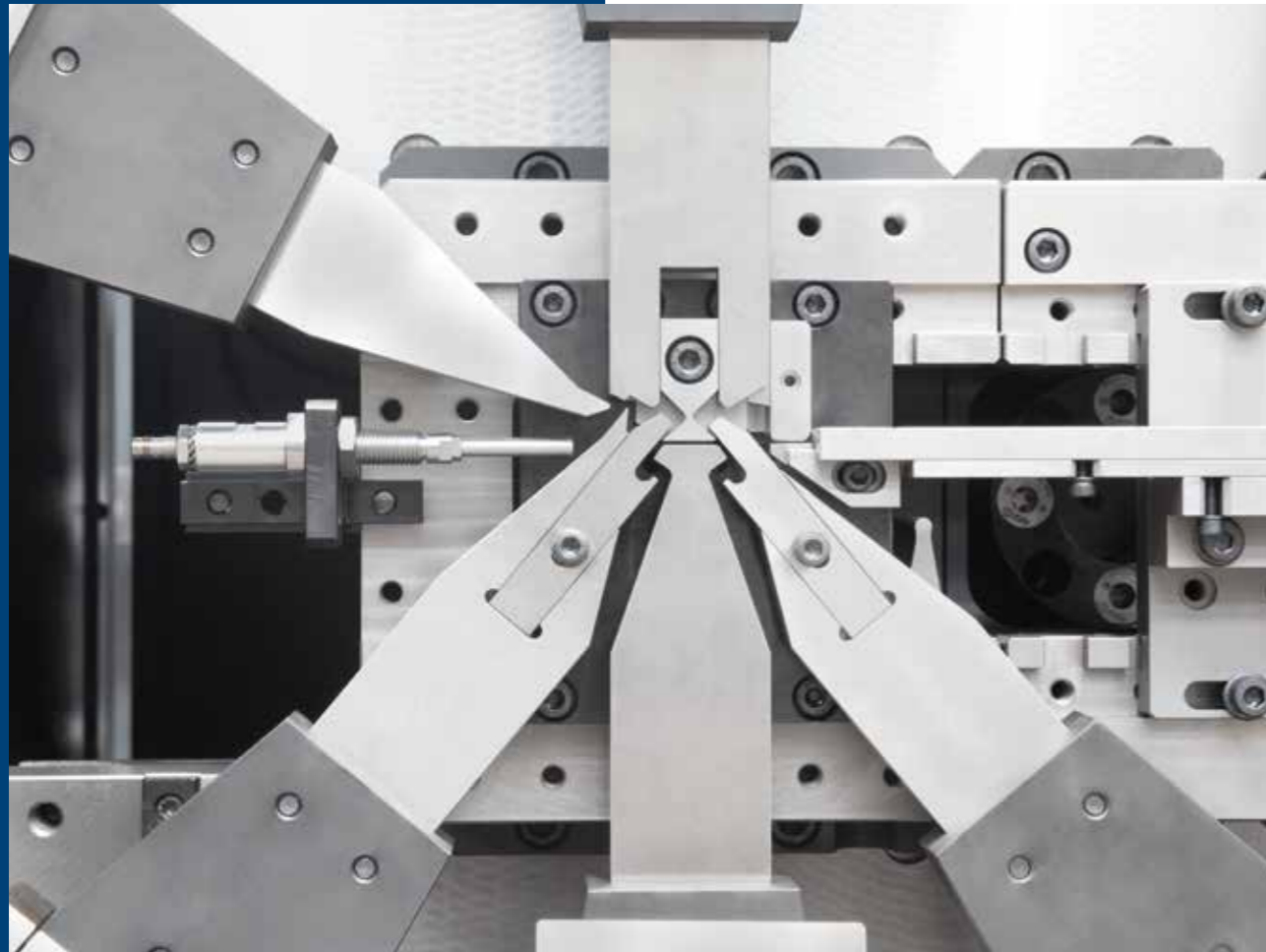

LEANTOOL

Progressive

Application:
Implementing new tools according to the linear, progressive and progressive component principle

Highlights at a glance

- Up to 70% standard tools regardless of task
- Up to 50% lower manufacturing costs compared to conventional progressive tools
- Simpler tool technology, since tool movements from 3 sides are performed by the machine by default
- No strip lifting in the tool
- Less material waste compared to conventional progressive tool solutions



LEANTOOL Progressive combines the strengths of traditional progressive tool technology with the strengths of Bihler machine technology. The tools consist of a large number of standardized tool parts made of standard parts and blanks. The machine allows individually controllable movements that can be implemented from above, from below and from the side. All this reduces the overall effort and complexity in the tool and guarantees simplicity, speed and safety.

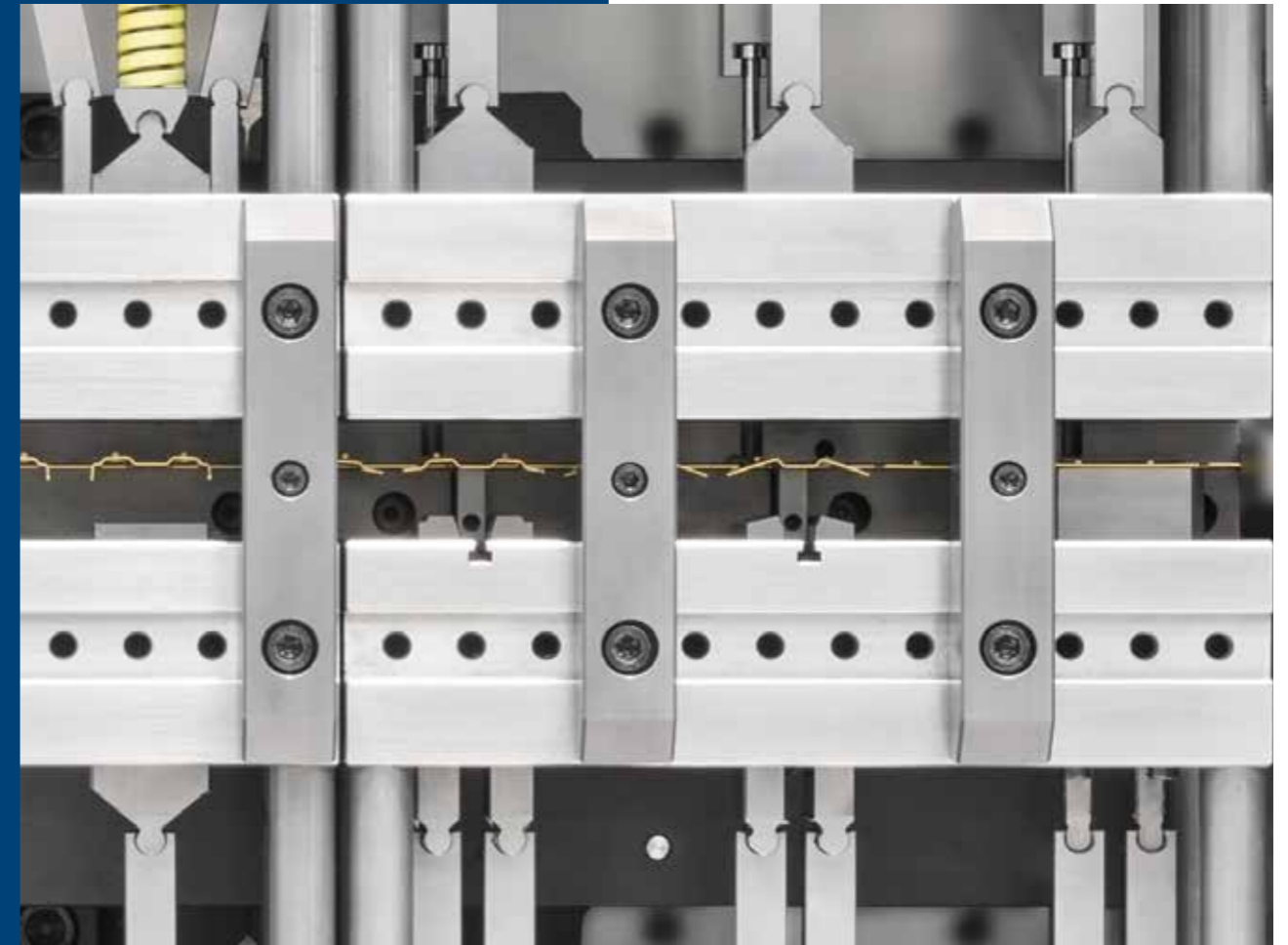

Basic equipment

RM-NC and GRM-NC are provided with basic equipment to operate the LEANTOOL radial and LEANTOOL progressive tool concepts. The basic equipment provides the interfaces for both concepts and the corresponding standard parts.

The basic equipment includes tool carriers for implementing the basic tools as well as base plates for attaching the punch holders and punches. The entire basic equipment is compatible with all associated standard parts of both tool concepts.

Tool carriers

Compatible with LEANTOOL Radial, LEANTOOL Progressive and for adapting existing tools.

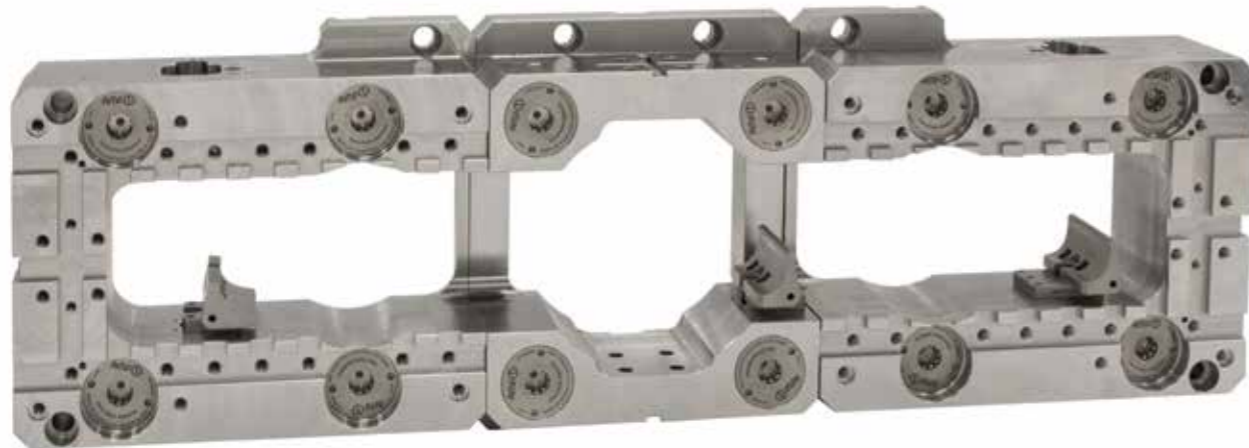

Base plates

Compatible with LEANTOOL Radial, LEANTOOL Progressive and for adapting existing tools.



Description

- R60 LEANTOOL Radial RM-NC
- R100 LEANTOOL Radial GRM-NC
- F200 LEANTOOL Progressive RM-NC
- F250 LEANTOOL Progressive GRM-NC

Online standard parts catalogue

An online standard parts catalogue is available for the complete LEANTOOL system (LEANTOOL Radial R60 / R100 and LEANTOOL Progressive F200 / F250). This provides you with a quick overview of the entire product portfolio. (www.bihler.de)

Understanding standard parts

You will also find all standard parts in the "Bihlerplanning" WebApp. In the WebApp, each standard part is featured virtually together with a specific forming example, and technical, functional and cross-system details are explained. (www.bihlerplanning.de)

Ordering standard parts

You can order all LEANTOOL standard parts for radial and progressive versions quickly and easily via the Bihler spare parts sales service.

Spare parts sales

Phone: +49(0)8368/18-135

E-mail: spare.parts@bihler.de

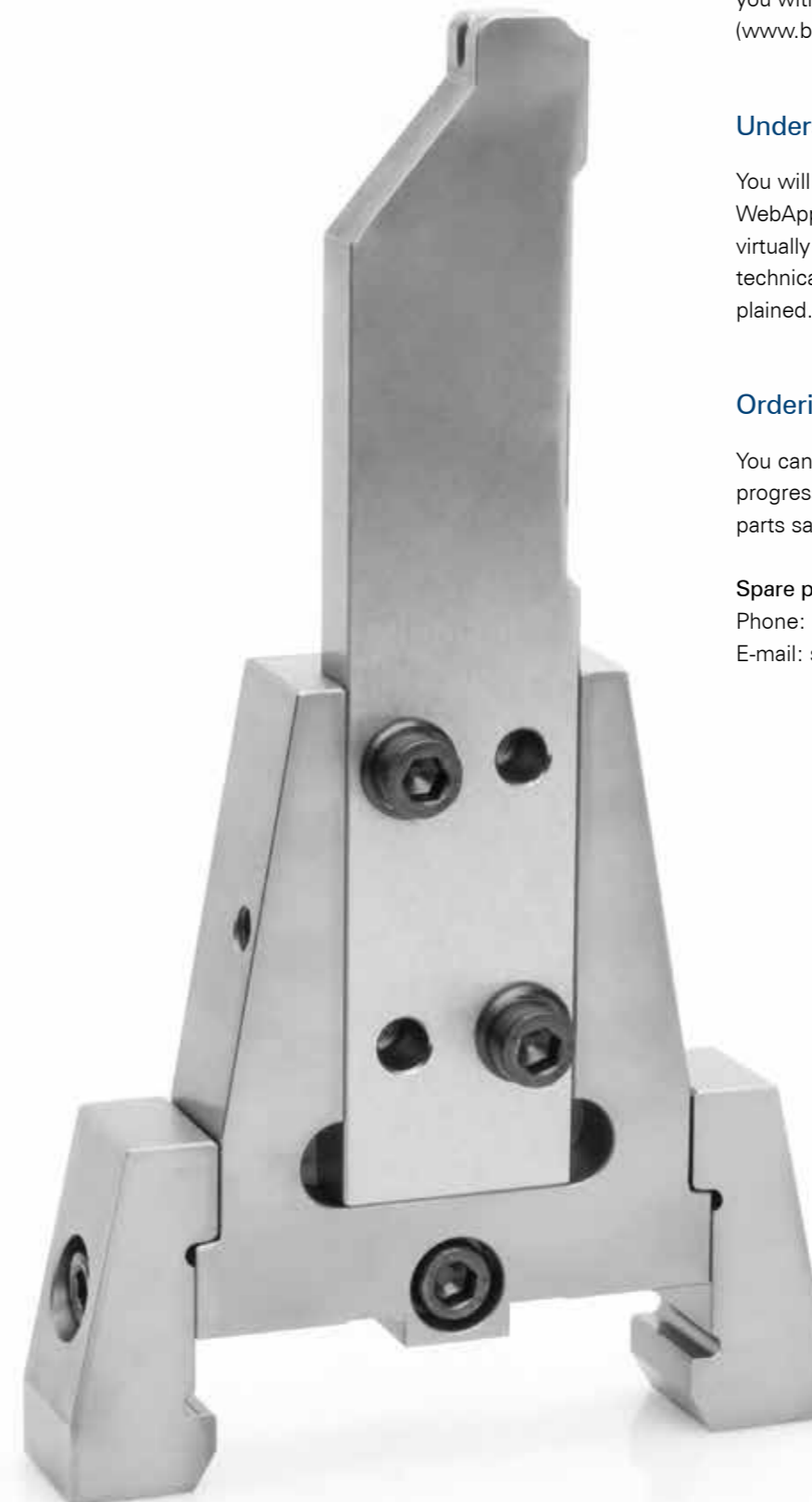

RM-NC / GRM-NC

Standardized machine platform

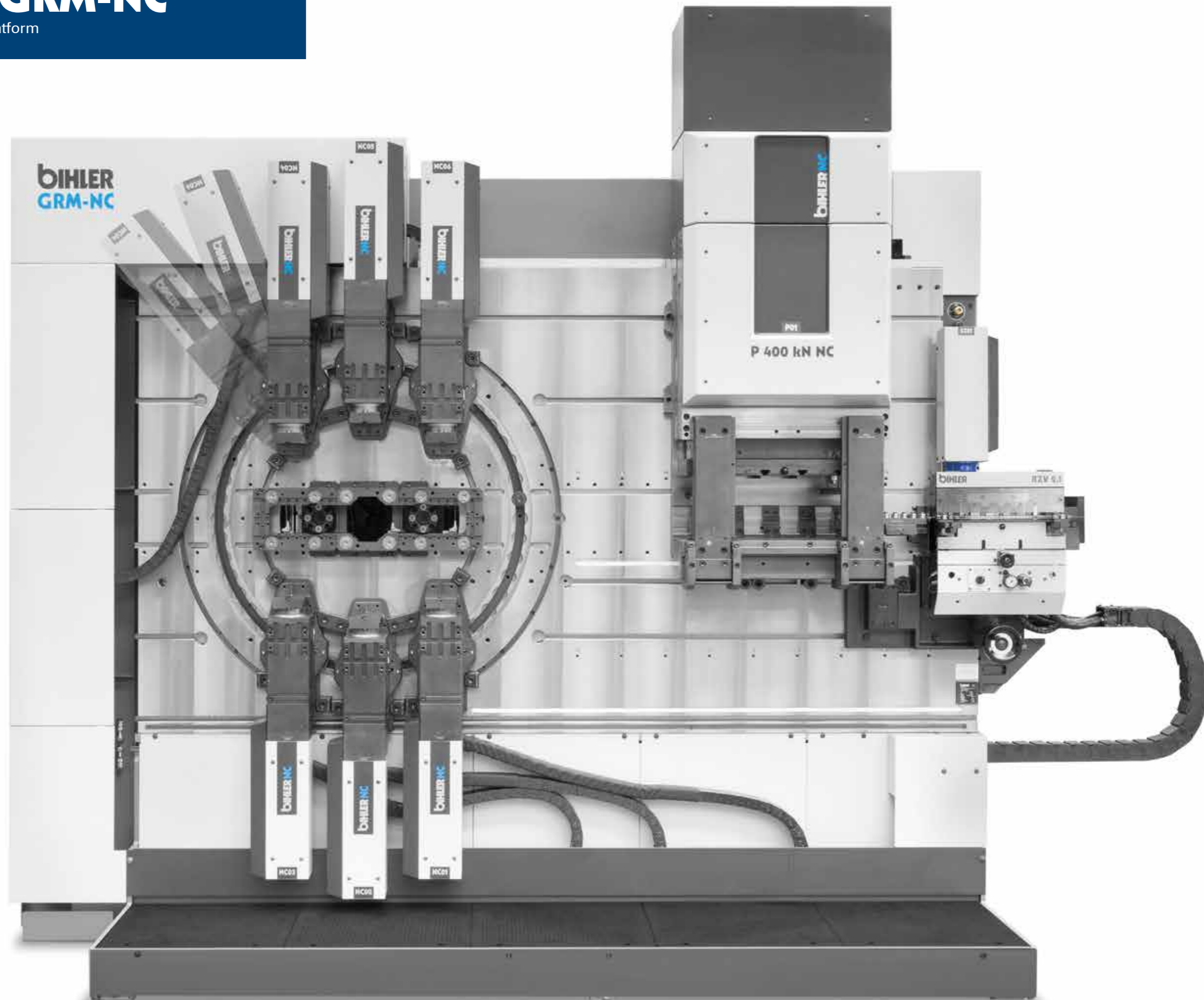

“How is each stamped and formed part manufactured?”

The new, free “Bihlerplanning” WebApp provides quick answers to this and many more questions. The WebApp is the ideal tool for planners and designers. It provides valuable support for component planning as well as tool design for stamped and formed parts from strip and wire material. The WebApp contains a sample database with a wealth of Bihler knowledge in addition to tool designs (strip and wire parts) in STEP format.



Forming steps and stage plan

Helpful source of inspiration

The WebApp offers an easy and quick overview of all aspects for implementing stamped and formed parts (bending steps, tool). Additional information such as production speed, setup time and processing time per batch will be outlined clearly. We are continuously expanding the case studies and other features for component and tool planning for you.

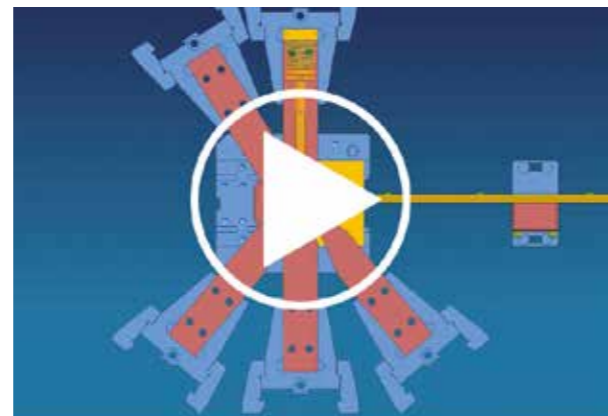

Animation of forming steps

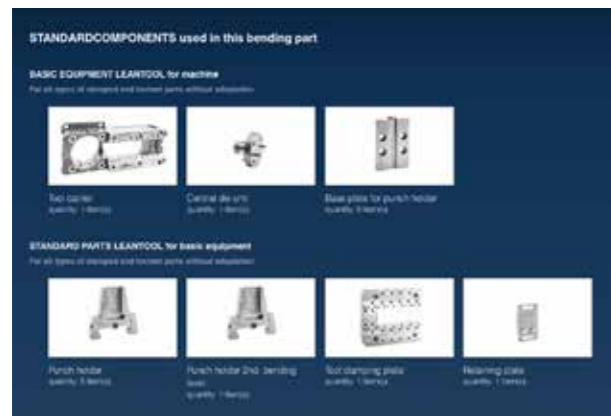

Tool technology and tool standards

Free registration

You can register at www.bihlerplanning.de. You will then be able to access and use our WebApp free of charge.



1.) Comparison of planning and costing effort

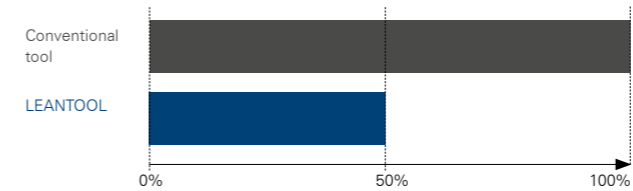

2.) Comparison of throughput time for tool implementation

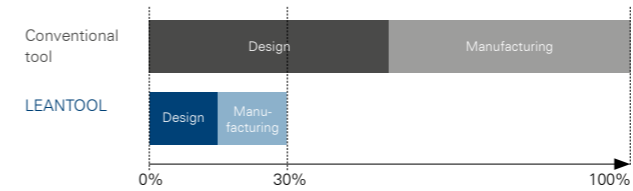

3.) Comparison of time for initial setup (= machine downtime)

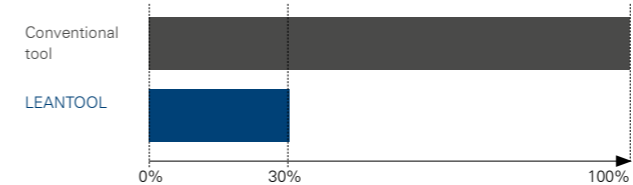

4.) Comparison of production costs for bending tool

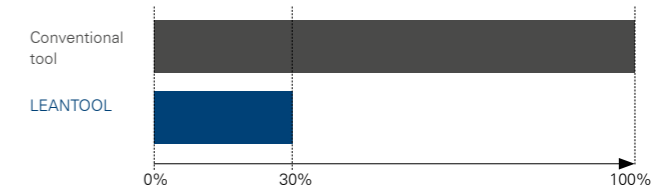

5.) Comparison of setup time

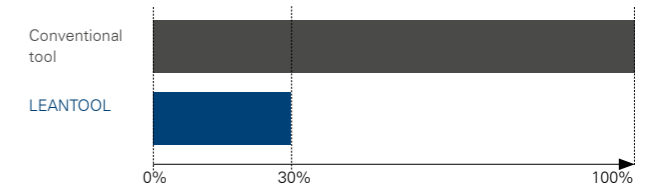

6.) Comparison of machine and tool technology*

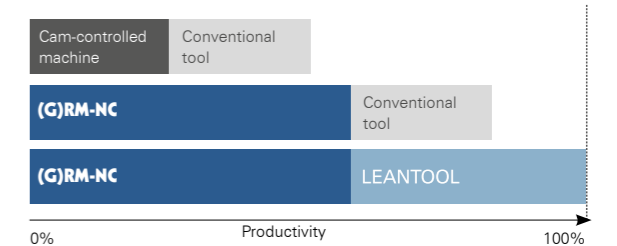

*Applies to smaller batch sizes, not for continuous operation.

Technical recommendations for rough planning

Radial equipment: R60 for RM-NC / R100 for GRM-NC

- Wire diameters up to approx. 4mm / 6mm
- Strip dimensions up to approx. 2mm×40mm / 2mm×60mm
- If the bends are within the main workspace, the formed part can generally be mapped with the modular tool kit.
- Up to approx. 8 bends for the bending part (for >8 bends the progressive principle is recommended)

Main workspace RM-NC (Ø 60mm)
Main workspace GRM-NC (Ø 100mm)

Progressive equipment: F200 for RM-NC* / F250 for GRM-NC

- Strip dimensions up to approx. 2mm×40mm / 2mm×60mm
- Module length: approx. 200mm / 250mm

*available as of Q3/2019

LEANTOOL

Training and consulting

Information event

General overview of the LEANTOOL system as well as extended training and consulting. In addition, a short-term feasibility analysis for inquiries is possible.

Target group: Stakeholders or customers without LEANTOOL experience or with specific requests regarding feasibility

Contact and coordination directly through Process planning/Technical sales;
Phone: +49(0)8368/18-141; leantool@bihler.de

Basic training

Sharing of basic knowledge regarding planning and design of LEANTOOL tools. After the seminar, participants are able to design and assemble LEANTOOL tools.

Target group: Designers, planning & design staff, e.g. as a seminar for several participant groups at once

Contact and coordination through Customer Support
Phone: +49(0)8368/18-176; consulting@bihler.de

Consultation for initial setup

Project-specific consultation for individual customers. Monitoring and guidance during initial LEANTOOL setup and commissioning. Our LEANTOOL experts share their knowledge in close cooperation with the customer.

Target group: Customers with LEANTOOL based production concepts

Contact and coordination through Customer Support
Phone: +49(0)8368/18-176; consulting@bihler.de

Development of manufacturing process

Project-specific consultation for individual customers. Development and preparation of a production concept based on LEANTOOL technology. Our LEANTOOL experts share their knowledge in close cooperation with the customer.

Target group: Customers with LEANTOOL based production concepts

Contact and coordination through Customer Support
Phone: +49(0)8368/18-176; consulting@bihler.de



FLOATING LICENCE

- NX MACH3 with PDW
- Tool design (NEW)
- Kinematics with simulation
- Including LEANTOOL

Price 22,250.- Euro
with or without yearly maintenance (3,560.- Euro)

(offer valid only in connection with a (G)RM-NC machine)



Perfect support for your success

Benefit from our vast experience. Our LEANTOOL team supports you in finding the solution for new stamping and forming tasks on the servo-controlled RM-NC and GRM-NC machines. Our experts demonstrate how to efficiently plan a new stamped and formed part as early as the quotation stage and offer it cost-effectively.

Contact us:
Phone: +49(0)8368/18-141, leantool@bihler.de



Process planning / Technical sales team (left to right): Reinhard Böck, Norbert Immler, Marc Walter, Thomas Zettlmeier, David Walk

Otto Bihler Maschinenfabrik GmbH & Co. KG

Lechbrucker Str. 15

87642 Halblech

GERMANY

Phone: +49(0)8368/18-141

Fax: +49(0)8368/18-146

leantool@bihler.de

www.bihler.de