

WOOD

www.win2trade.com



Windows
Doors
Blinds
Sliding systems

WOOD

Windows

Casement Flush

Casement windows are based on the construction of **outward opening windows**. Internally glazed, with a modern concealed multi-point locking system, the design provides high security features. Available in pine, oak, and Meranti in different installation depths (listed below).

Casement **Flush** is specially designed to replicate a period window while incorporating the most modern operation and security features. Often referred to as a conservation window, the design is characterised by a leaf that sits within the frame to create a flush finish externally.



68 Casement Flush /zoom/

Casement **Storm-proof** is the most frequently chosen wooden window design in the UK. It reflects a proven ability to withstand exposure to adverse weather conditions. The leaf stands out boldly from the frame, giving excellent gasket compression and the best weather rating available.



68 Casement Storm-proof /zoom/

www.win2trade.com

2

Vertical Sliding Sash windows - This traditional British construction was adapted originally to living places without ventilation chimneys. They were created so as not to occupy space either the in narrow streets or in small apartments. Internally glazed, with a modern concealed multi-point locking system the design provides high security features. Available in pine, oak, and Meranti in different installation depths (listed below).

The Sliding Sash **Spiral Balance** system provides a lift mechanism with a tensioned spring. Predominantly used in new building construction, it provides an efficient and cost effective solution for this style while retaining all the unique features of a sash window.



Sliding Sash **Cords & Weights** profile uses pulleys and weights as the lift system. It is primarily used when dictated by building circumstances or conservation requirements. This profile provides maintenance of the character and charm of the building while incorporating modern technologies, security, and performance.



3

WOOD

Windows

Sliding Sash SB Spiral Balance

Sliding Sash CW (Cords & Weights)



WOOD

Lift & Sliding system HS is a solution for big open glass surfaces. It also improves thermal insulation, is functional, and aesthetic. It is possible to apply wide profiles as well as covered mechanisms which can lift up to 400-kg-heavy sashes but also have energy-saving glass with $U_g=0,5$ W/m²K. The sliding mechanism (wheels) are hidden in the sash's frame. The handles and the rail are the only visible elements.



WOOD

Lift & Sliding system (HS)

This system is highly suitable and economical for large-scale areas.

Fittings are a very important element of the sliding door's equipment which facilitate service.

Lift & Sliding system (HS) - scheme

We are pleased to offer both aluminium and wooden thresholds as well as different sash depths (92 | 78 | 68).

Scope - the dimensions of a single sash

width: 700 - 3300 mm, height: 850 - 3250 mm, weight: up 400 kg

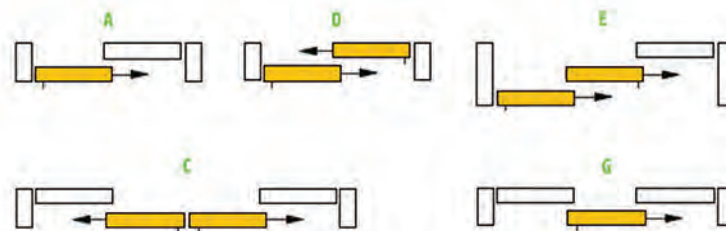

In the Soft-line as well as in the Retro profile, there is NO Alu-drip.

In the RETRO profile, RETRO glazing beads are available

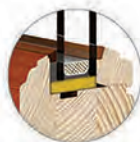

By default sliding doors have longer-than-traditional handles because of the sash's weight. Their length provides ease of use.

Lift & Sliding system (HS) - handles



92 HS Soft-Line
(Aluminium threshold)



68 HS Soft-Line
(Wooden threshold)



68 HS Soft-Line



78 HS Soft-Line



In the standard model a low aluminium threshold is offered (built into the ground and almost invisible).



Colours available

- 1 - White (RAL 9016)
- 2 - Brown
- 3 - Silver (F1)
- 4 - Gold (F4)

Optional



- 1 Inside: handle / Outside: hand lever
- 2 Inside: handle with cylinder for locking / Outside: hand lever
- 3 Both sides: handle with cylinder for locking



WOOD

Tilt & Slide system (PSK – Parallel slide)

Tilt & Slide system (PSK – Parallel slide) - is an alternative for inward-opening windows or French Doors. There is optimal surface usage in the area of terrace and garden exits. With the PSK it is possible to tilt the leaf for ventilation and later to move it to the side. After opening, the leaves hide smoothly behind each other so as not to occupy the space of a room. When closed they look identical to inward opening TT windows, or balcony doors. Available with window threshold (in the standard model) or low threshold (20 mm - optional).

PSK doors are innovative doors which entail a variety of advantages due to their construction.



WOOD

PSK - Scheme

Fittings are a very important element of a window's equipment which facilitate service.



68 PSK Soft-Line

In standard

- > double glazing
- > weatherboard aluminium
- > EPDM seals white or brown
- > Soft-Line profile

Optional

- > Other colours of caps which cover the ironmongery (sliding system):

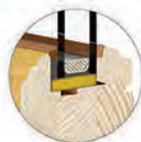

Retro profile (with Retro glazing beads available)



PSK Threshold 20mm (optional)



PSK Standard threshold



Optional: Second sash with Turn&Tilt, Tilt&Turn function, or with only a fixed panel (in the standard model).

Scope - the dimensions of a single leaf

width: 640 - 2000 mm, height: 700 - 2350 mm, weight: up to 200 kg

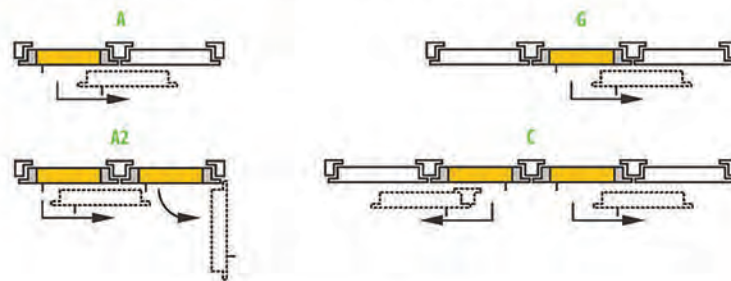

By default, PSK-doors have longer-than-traditional handles although shorter than HS-handles.

PSK - Handles

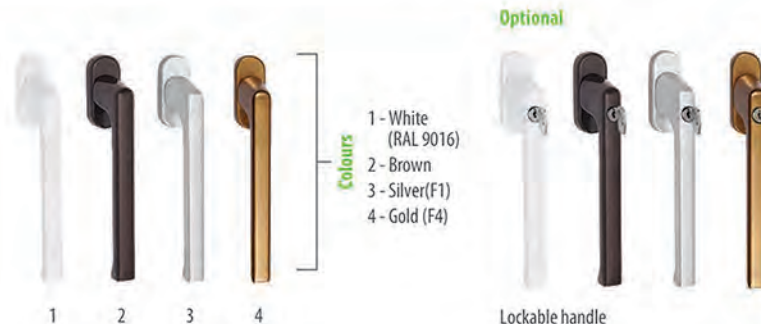

- Colours
- 1 - White (RAL 9016)
 - 2 - Brown
 - 3 - Silver(F1)
 - 4 - Gold (F4)

Optional

Lockable handle



WOOD

Balcony doors Soft-Line



Balcony doors Retro



The Casement door (**Balcony door**) is a solution for customers who are looking for highly popular **inward opening** balcony-or-terrace entrances made of wood. The Casement (Balcony) door looks identical to TT windows except that the bottom part of the leaf is of double height strongly supporting the leaf. Our casement (balcony) doors fully correspond with TT-window systems (Eco, Classic or Traditional - look further in the catalogue, page 16-21). As part of the same window/door family we have two versions of the window frame and the window leaf: the gently rounded line (Soft Line) and a Retro style design. Thresholds available: 32 mm (recommended), 20 mm, standard window threshold, and no threshold.

The Soft-Line profile is one of the most popular versions for a balcony window.

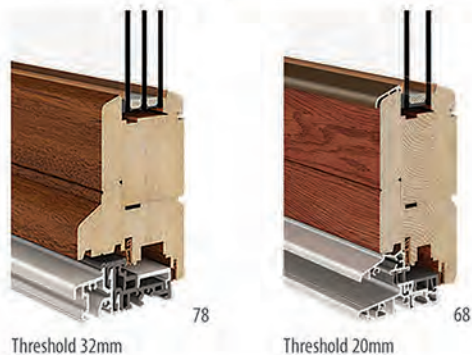

Options

Available installation depths:
92, 78 and 68mm



also Retro design with Retro
glazing beads available

Retro design can be used anywhere you want to keep the historic character of a building. The window style is in perfect harmony with its architecture.



Options

Available installation depths:
92, 78 and 68mm

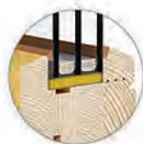

also Soft-Line design
available (with or without
aluminium drip cup)

www.win2trade.com

8



Fittings are an important element of the window's features which facilitate operation. We use identical fittings as in TT-windows, which are also equipped with micro-ventilation, and an anti-tampering device.

Unilateral (inside) window handles A / B / C *



* Suitable for schemes shown

Bilateral handles with cylinder (allows to Turn & Tilt the leaf) A / B / C *



Bilateral handles with cylinder (only turn function available) B / C *



Note: The Casement (balcony) doors open only inwards; for outward opening, see 'Doors'.

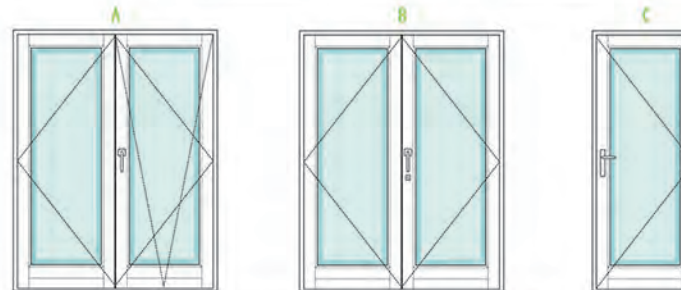

*For further information please contact our sales department.

9

WOOD

Balcony doors Handles



Balcony doors Scheme



WOOD

FS-IN inward-opening Bi-Folding doors

Folding-sliding (inward-opening Bi-Folding doors) allow large surfaces to be simply swept aside. The door parts fold on hinges on one side: to the interior (this page) or to the exterior (next pages). They are ideal for generous living spaces, or for conservatories and very large areas. Whole glass walls may be almost entirely opened while the individual elements are folded and pushed aside to the left or right into a corner. Folding sashes look just like TT-window leaves (for further information see pages 16-21) so as to make your house more beautiful.

The folding door is an ideal solution for the entirely open large window walls.



FS-IN Standard threshold



FS-IN Soft-Line / Standard threshold /



FS-IN low threshold



FS-IN Soft-Line / low aluminium threshold /

92, 78, and 68-mm installation depths are available



also Retro available



The FS-IN system enables the production of up-to-6300-mm-wide and up-to-2400-mm-high glazing spaces.

WOOD

FS-IN Scheme

Scope the dimensions of a single leaf

width: 640 - 1000 mm, height: 900 - 2350 mm, weight: up to 130 kg, number of panels of equal size: 3-7

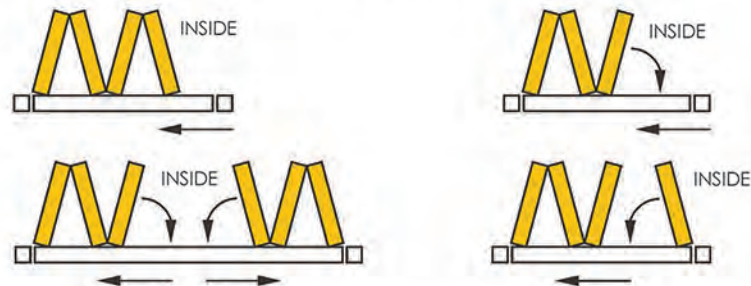

In our assortment different folding door handles are available. Depending on the type of opening, the following handles can be used:

Master (Active) leaf



Unilateral (inward) handle



Door-type bilateral handle



Casement/Balcony-type handle (tilting master leaf)

Other leaves



Handle type is dependent on the number of leaves (chosen according to the system)



FS-IN Handles



WOOD

FS-OUT outward-opening Bi-Folding doors

Folding-sliding (outward-opening Bi-Folding doors)

let large surfaces to be simply swept aside. The door parts fold on hinges on one side: to the interior (previous pages) or to the exterior (this page). They are ideal for generous living spaces, or for conservatories and very large areas. Whole glass walls may be almost entirely opened while the individual elements are folded and pushed aside to the left or right into the corner. These doors' design perfectly suits Sliding Sash and Casement windows, and the French doors, so as to make your house more beautiful. The folging sashes have almost identical glazing beads.

Folding doors are ideal for entrance to your garden, for apartments, or restaurants.



FS-OUT Aluminium threshold



FS-OUT Wooden threshold



With almost identical glazing beads these doors' design perfectly suits Sliding Sash and Casement windows, and the French doors



The FS-OUT system enables the production of up-to-7200-mm-wide and up-to-3400-mm-high glazing spaces (ask the seller for further information).

Scope the dimensions of a single leaf

width: 640 - 900 mm, height: 700 - 3400 mm, weight: up to 130 kg, number of panels of equal size: 3-8

Many sample opening designs are available. Below you will find 3+2 scheme:

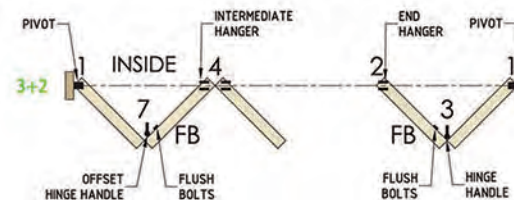

In our assortment different folding door handles are available.

Master (Active) leaf



Other leaves



Interlocking leaf



WOOD

FS-OUT Scheme



FS-OUT Handles



WOOD

We offer **Entrance Doors** in various finishing styles such as modern, classic, or traditional, as well as with solid finishing with extensive combinations of wood types, colours, vision panels, and glass types. Both inward and outward opening doors are available.



WOOD

DCS - Door Classic Soft-Line

The **Classic** line ideally corresponds with inward opening wooden windows both with the Classic line and with the Eco line. Glazing beads and the curve of the profile complement each other in an ideal whole.



Doors may be equipped with an aluminium rebate drip of the wooden leaf.

If door leaf includes glass then the glazing bead is always located inside to keep the door much safer. Outer surfaces may have milled additions. Glazing may be mounted too.



Solid Doors are completely flat, available with or without a glass panel, either inward or outward opening. They seem to be made of a single panel due to the hidden rails. A thick stabilizing-isolating layer provides their extraordinary warmth.

DP - Door

DCR - Door Classic Retro

Design matches inward-opening windows from the **Retro** line (Classic, Eco, and Traditional).



RETRO profile can be used anywhere where the historic character of the building is important.



Traditionally **decorative doors** with double-sided trim are ideal for refurbished buildings and also for new building keeping an old fashioned character.

DF - Door

WOOD Windows

The **Traditional** line of wooden windows has an **inward-opening TT** (Turn&Tilt or Tilt&Turn) system. While the Traditional product uses modern technology in terms of wood processing, painting, and glazing, the windows faithfully look like ones from 40, 60, or more years before. These windows are most often chosen by customers and investors mostly for buildings where the conservator of historical monuments has strictly specified the look of the joinery. Available in pine, oak, larch and Meranti in different installation depths (68, 78, 92 mm). Available in stains (Lazur) and RAL colours, double or triple glazed.



WOOD Windows

Traditional - T1S

In standard is Soft-Line available.

Various models distinguish themselves as conservation windows.

Traditional - T2R



92 Soft-Line

Available in stains (Lazur) and RAL colours.



78 Soft-Line



68 Soft-Line



92 Retro



78 Retro



68 Retro



Traditional - T2S

Other models of the Soft-Line version are also available.

Optimal thermal insulation benefits the client, by preventing the loss of energy.

Thermal parameters



92 Soft-Line

This profile works best in buildings with a historical style, no matter whether a magnificent palace, a restaurant, or an old building in town.



78 Soft-Line



68 Soft-Line

Options

68

Classic | Eco | Traditional

U-value for glass

1,1
U_g [W/m²K]



0,7
U_g [W/m²K]



Spacer

Alu

Swisspacer

Alu

Swisspacer

U-value for the window *

1,37 Uw [W/m²K]

1,28 Uw [W/m²K]

1,13 Uw [W/m²K]

1,01 Uw [W/m²K]

* Heat transfer coefficient for reference windows: 1230 mm x 1480 mm



WOOD

Windows

The Eco line of wooden windows uses an **inward-opening TT (Turn&Tilt or Tilt&Turn)** system. It's a modern window design used to produce inward opening (tilting and turning) windows in a wooden frame distinguishing themselves by **ECO**-logy and **ECO**-nomical price. They are equipped with an **aluminium rebated drainage lip which protects the outside of the leaf (the rebate) from damaging water, sun, or frost.** Whichever version it is (Soft line or Retro), the Eco product has its outer aluminium lip always visible (painted in a colour similar or identical to the frame). Available in pine, oak, larch, and Meranti in different installation depths (68, 78, 92 mm), double or triple glazed.



WOOD

Windows

Eco - E1S

In the standard model is Soft-Line with a wing cover in a function of a weather-change protection, and an aluminium lip with drainage slots is available.

Wooden windows in RETRO Design: with RETRO glazing bead and aluminium drip.

Eco - E1R



92 Soft-Line



78 Soft-Line



68 Soft-Line

Available in stains (Lazur) and RAL colours.

In the standard version, the drips are painted in white, brown, anode silver, or anode olive green according to one's liking. Optionally, the drip may be painted in any RAL colour.



92 Retro



78 Retro



68 Retro



Eco - E2HL

Hard-Line model - ideally suits modern style homes and public buildings.

Optimal thermal insulation benefits the client, by preventing the loss of energy.

Thermal parameters



78 Hard-Line



68 Hard-Line

Aluminium drip colors:

white

brown

silver

olive



* Any RAL colour

Classic | Eco | Traditional

78

U-value for glass

1,1
Ug [W/m²K]

0,7 | 0,6
Ug [W/m²K]



Spacer

U-value for the window *

Alu 1,33 Ug [W/m²K]
Swisspacer 1,24 Ug [W/m²K]

Alu 1,06 | 1,00 Ug [W/m²K]
Swisspacer 0,97 | 0,91 Ug [W/m²K]

* Heat transfer coefficient for reference windows: 1230 mm x 1480 mm

WOOD

Windows

Classic - C1S

The Classic line of wooden windows is an **inward-opening TT (Turn&Tilt or Tilt&Turn)** system. This is a modern single window for customers demanding **the wooden window to have all visible elements made of wood**, to look as if it were made entirely of wood. Customers accept the use of aluminium lips but of course with a wooden overlay which ideally and aesthetically masks the lip. The role of the lip is water drainage. The wooden overlay is made of the same type of wood as the rest of the window. Available in pine, oak, larch and Meranti in different installation depths (68, 78, 92 mm). Available in stains (Lazur) and RAL colours.

In the standard model Soft-Line is available. The aluminium lip is covered with wood in different shapes (see C1S and C2S).



Available in stains (Lazur) and RAL colours.

92 Soft-Line

78 Soft-Line

68 Soft-Line

Classic - C2S

The wood-covered water lips may have different forms. All others are the same.



As part of the same installation depth and the same heat transfer efficiency, we have two versions of the window frame and the window leaf: the gently rounded line (Soft-Line) and a version in Retro style.

78 Soft-Line

92 Soft-Line

68 Soft-Line



WOOD

Windows

Classic - C1R

C1R represents a classic window with RETRO glazing beads and RETRO aluminium lip wooden overlays.

We also manufacture renovation windows of the CLASSIC line with style rail.



92 Retro

78 Retro

68 Retro

Optimal thermal insulation benefits the client, by preventing the loss of energy.

Thermal parameters

	U-value for glass	Spacer	U-value for the window *
92	0,6 Ug [W/m²K]	Alu	0,96 Uw [W/m²K]
		Swisspacer	0,87 Uw [W/m²K]
Classic Eco Traditional	0,5 Ug [W/m²K]	Alu	0,90 Uw [W/m²K]
		Swisspacer	0,81 Uw [W/m²K]

* Heat transfer coefficient for reference windows: 1230 mm x 1480 mm

WOOD

Windows



WOOD

Windows

Renovo windows are mostly used in France and Italy. The renovation window-frame system allows the installation of the window without dismantling the old wooden frame. Available in pine, oak larch and Meranti in different installation depths (68, 78, 92 mm). Available in stains (Lazur) and RAL colours, double or triple glazed.

Thanks to the new, well conceived renovation profiles, window replacement is much easier. These windows are particularly popular in France.

Renovo Eco Superstructure with RENOVation profiles

Renovo Eco

Renovo windows with aluminium lip - in Soft-Line version.

Soft-Line



Options



R18E1S 68 (Renovo 18 Eco 68 Soft-Line)



Recess of the window frame and sill profile of the window.



Type R18E1S + sill ext

Renovo Classic

These windows are favoured by customers who expect the natural wood look of the window.

Specific trim profiles mask the insulation.

Renovo Classic Superstructure with RENOVation profiles

Retro

Windows with renovation frames are ideal for assembling in historic buildings.



Options



R30C1R 68

www.win2trade.com 22



Type T3S + sill ext



Type R30C1R + sill ext



Type R30C1R + sill ext

23

WOOD

✓ WOOD STRUCTURE

STAINS (LAZUR) - Pine



STAINS (LAZUR) - Meranti

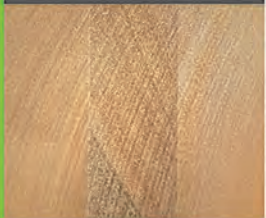

STAINS (LAZUR) - Oak

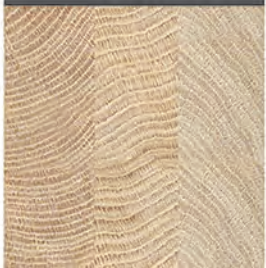

Pine MICRO (finger-jointed)-under RAL colours recommended



Pine NATUR

II Price Group

I Price Group



ITALIAN STONE PINE



OLD PINE



CYPRESS



SIPO MAHOGANY



OAK



SAPELE



ITALIAN STONE PINE



OLD PINE



CYPRESS



SIPO MAHOGANY



OAK



SAPELE



ITALIAN STONE PINE



OLD PINE



CYPRESS



SIPO MAHOGANY



OAK



SAPELE



Meranti



Oak

I Price Group

extras*



CHERRY



WALNUT



AFROMOSIA



IPE BRAZILIAN WALNUT



EBONY



CLEAR*



CHERRY



WALNUT



AFROMOSIA



IPE BRAZILIAN WALNUT



EBONY



GOLD OAK**



CHERRY



WALNUT



AFROMOSIA



IPE BRAZILIAN WALNUT



EBONY



GOLD OAK***

WOOD

< COLOURS



WOOD

For inward opening TT wooden windows

We use HOPPE brand handles offering a wide range of different shapes with different surfaces and colours.



WOOD

Window handles

In the standard there are HOPPE TOKYO handles. Other models are available on request.

Form:



Options



- 1 - White (RAL 9016)
- 2 - Brown (RAL 8019)
- 3 - Old Gold F4
- 4 - Titan F9
- 5 - Silver F1

Colours

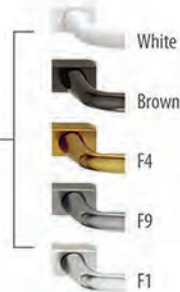

Glazing bars are a design element for windows. In wooden windows they support the character and style of the house.

Glazing bars

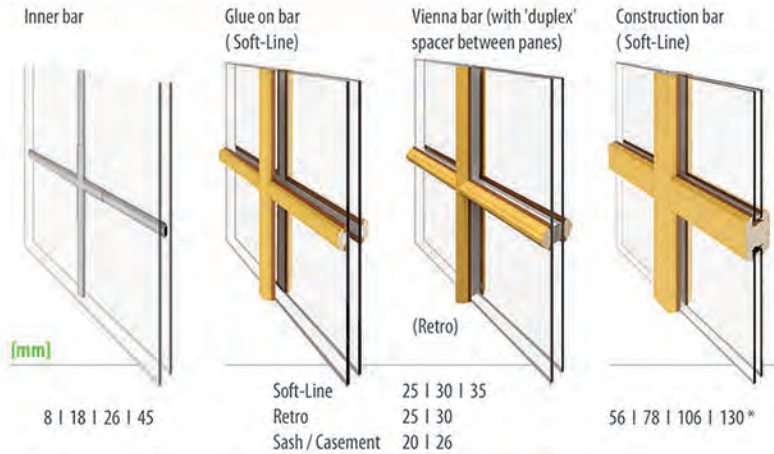

Door handles

We offer a wide selection of high-quality handle sets.

Standard



Options Hoppe



Various bars with or without 'duplex' spacer between the panes are available:

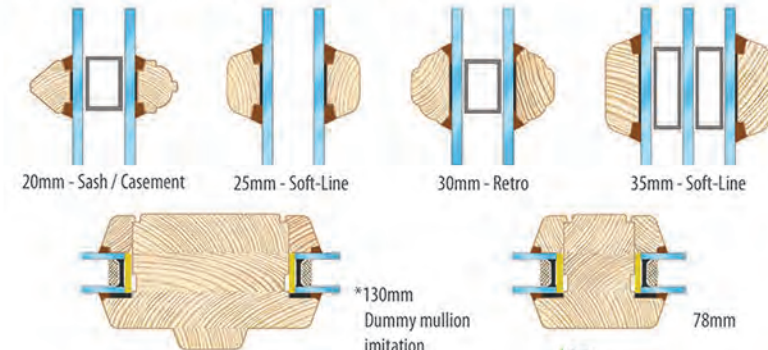

Glazing bars' cross section





PVC



Wood-Alu



Alu



Blinds



Win2Trade
ul. Andersa 38, 15-113 Białystok
POLAND

Tel. +48 85 652 38 56
fax +48 85 675 24 98

www.win2trade.com
e-mail: contact@win2trade.com

FR
Tel. +48 85 733 18 13
contact@win2trade.fr

BE
Tel. +48 85 733 18 14
contact@win2trade.be

DE
Tel. +48 85 733 18 12
kontakt@win2trade.de

IT
Tel. +48 85 733 18 11
contattaci@win2trade.it



Garage gates



Roof windows